

# HUTCH SUSPENSION

## Underslung Suspension

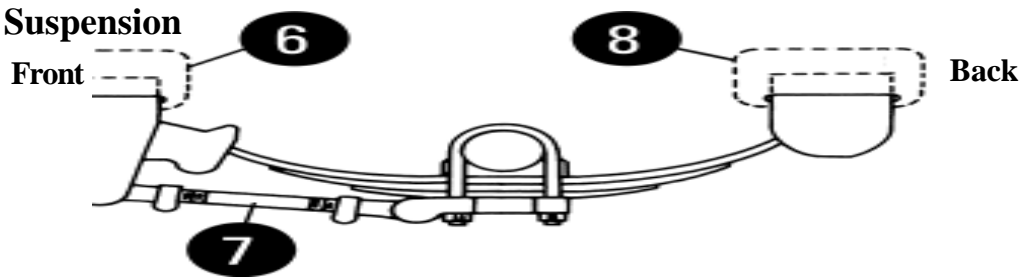

Fig. 1



Fig. 2



Fig. 3



Fig. 4



Fig. 5



Fig. 5a



Fig. 5b



Fig. 6



Fig. 7



Fig. 8

## Hutch H7700 / H9700 Suspension

### Fabricated Weld-On & Bolt-On Flange Mount for H9700 Suspension

| Part #   | Fig.# | Description     |
|----------|-------|-----------------|
| 7701-07  | 1     | LH Front Hanger |
| 7701-08  | 1     | RH Front Hanger |
| 16319-07 | 6     | Center Hanger   |
| 7703-07  | 8     | LH Front Hanger |
| 7703-08  | 8     | RH Front Hanger |

### Fabricated Undermount Hangers for H7700 Suspension

| Part #   | Fig.# | Description   |
|----------|-------|---------------|
| 20728-01 | 1     | Front Hanger  |
| 16319-02 | 6     | Center Hanger |
| 20732-01 | 8     | Rear Hanger   |

### Equalizer

| Part #   | Fig.# | Description               | A       | Bushing | Bolt Kit (Per Side) |
|----------|-------|---------------------------|---------|---------|---------------------|
| 16158-01 | 5     | One Bolt Bushing- 49"WS   | 16-1/2" | 7010-00 | 16353-01            |
| 750-03   | 5a    | Two Bolt Bushing- 49"WS   | 16-1/2" | 7010-00 | 10287-01            |
| 17604-02 | 5b    | One Bolt Bushing- 57.5"WS | 23-1/2" |         | 16353-01            |
| 16168-02 | 5b    | One Bolt Bushing- 61"WS   | 26-1/2" |         |                     |

WS = Widespread

### Torque Arm

| Part #   | Fig.# | Description              | Bushing | Bolt & Nut        |
|----------|-------|--------------------------|---------|-------------------|
| 715-00   | 2     | Rigid w/ 19 1/4" Centers | 722-00  | 719-02 & 10562-00 |
| 16398-04 | 7     | 18-1/2" to 21" Adj. Arm  | 722-00  | 719-02 & 10562-00 |
| 16398-07 | 7     | 20" to 22-1/2" Adj. Arm  | 722-00  | 719-02 & 10562-00 |

### Axle Attaching Parts

| Part #   | Fig.# | Description                             |
|----------|-------|---|
| 706-01   | 3     | Bottom Plate Assembly                   |
| 22215-01 | 4     | 3/4" High Spring Seat For 5" Round Axle |

### U-Bolts And Nuts

On Page 53



# HUTCH SUSPENSION

## Overslung Suspension

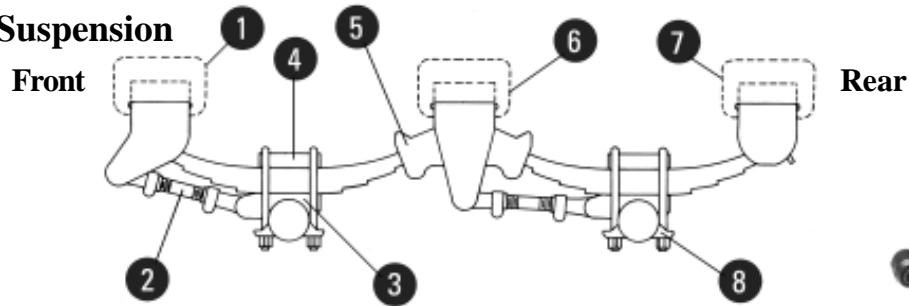

Fig. 1



Fig. 2



Fig. 2a



Fig. 3



Fig. 4



Fig. 5

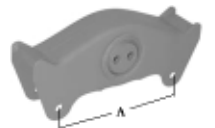

Fig. 5a



Fig. 5b



Fig. 6



Fig. 7



Fig. 8

## Hutch H7700 / H9700 Suspension

### Fabricated Weld-On & Bolt-On Flange Mount for H9700 Suspension

| Part #   | Fig.# | Description     |
|----------|-------|-----------------|
| 7701-07  | 1     | LH Front Hanger |
| 7701-08  | 1     | RH Front Hanger |
| 16319-07 | 6     | Center Hanger   |
| 7703-07  | 7     | LH Rear Hanger  |
| 7703-08  | 7     | RH Rear Hanger  |

### Fabricated Undermount Hangers for H7700 Suspension

| Part #   | Fig.# | Description   |
|----------|-------|---------------|
| 20728-01 | 1     | Front Hanger  |
| 16319-02 | 6     | Center Hanger |
| 20732-01 | 7     | Rear Hanger   |

### Equalizer

| Part #   | Fig.# | Description               | A       | Bushing | Bolt Kit (Per Side) |
|----------|-------|---------------------------|---------|---------|---------------------|
| 16158-01 | 5     | One Bolt Bushing- 49"     | 16-1/2" |         | 16353-01            |
| 750-03   | 5a    | Two Bolt Bushing- 49"     | 16-1/2" | 7010-00 | 10287-01            |
| 17604-02 | 5b    | One Bolt Bushing- 57.5"WS | 23-1/2" |         |                     |
| 16168-02 | 5b    | One Bolt Bushing- 61" WS  | 26-1/2" |         |                     |

### Torque Arm

| Part #   | Fig.# | Description              | Bushing | Bolt & Nut        |
|----------|-------|--------------------------|---------|-------------------|
| 16398-04 | 2     | 18-1/2" to 21" Adj. Arm  | 722-00  | 719-02 & 10562-00 |
| 16398-07 | 2     | 20" to 22-1/2" Adj. Arm  | 722-00  | 719-02 & 10562-00 |
| 715-00   | 2a    | Rigid w/ 19-1/4" Centers | 722-00  | 719-02 & 10562-00 |

| Part #   | Fig.# | Description                               |
|----------|-------|---|
| 16868-01 | 4     | Top Plate 3" Wide 7-1/2" Long             |
| 710-00   | 8     | Bottom Plate 5" Round Axle                |
| 19360-01 | 3     | 3/4" High Spring Seat For 5" Round Axle   |
| 19360-04 | 3     | 2-1/4" High Spring Seat For 5" Round Axle |

### U-Bolts And Nuts

On Page 53



# SUSPENSION PARTS

## Overslung Suspension

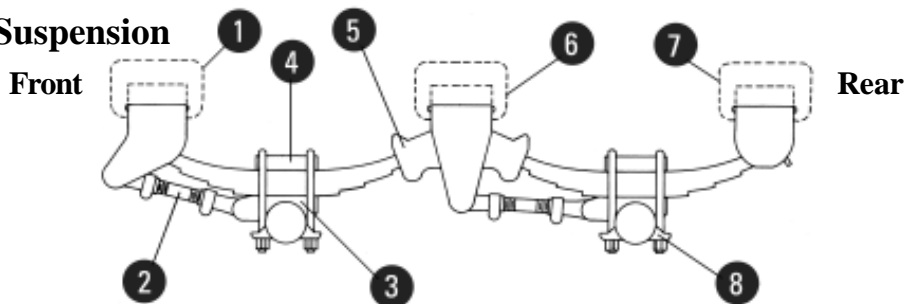

Fig. 1



Fig. 2



Fig. 2a



Fig. 3



Fig. 4

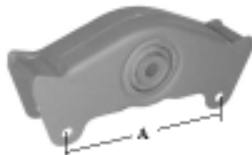

Fig. 5



Fig. 6



Fig. 7



Fig. 8

## Reyco Transpro 86 / 88 Series Suspension

### Flange Mount Hangers

| Part #   | Fig.# | Description     |
|----------|-------|-----------------|
| 338-1409 | 1     | LH Front Hanger |
| 338-1410 | 1     | RH Front Hanger |
| 338-1411 | 6     | Center Hanger   |
| 338-1412 | 7     | LH Rear Hanger  |
| 338-1413 | 7     | RH Rear Hanger  |

### Equalizer

| Part #   | Fig.# | Description      | A       | Bushing | Bolt Kit |
|----------|-------|------------------|---------|---------|----------|
| 338-378I | 5     | One Bolt Bushing | 16-1/2" | 321-194 | 334-343  |

### Torque Arm

| Part #  | Fig.# | Description                    | Bushing | Bolt & Nut |
|---------|-------|--------------------------------|---------|------------|
| 345-157 | 2     | 18-1/4" to 21-1/2" Adj. Arm    | 321-153 | 334-315    |
| 345-158 | 2a    | Rigid Arm with 19-7/8" Centers | 321-153 | 334-315    |

## Axle Attaching Parts

| Part #   | Fig.# | Description                               |
|----------|-------|---|
| 16868-01 | 4     | Top Plate 3" Wide 7-1/2" Long             |
| 710-00   | 8     | Bottom Plate 5" Round Axle                |
| 19360-01 | 3     | 3/4" High Spring Seat For 5" Round Axle   |
| 338-382  | 3     | 1" High Spring Seat For 5" Round Axle     |
| 19360-04 | 3     | 2-1/4" High Spring Seat For 5" Round Axle |

**U-Bolts And Nuts  
On Page 53**



# CHALMERS SUSPENSION

## 800 Series Truck Suspension

| Part #   | Fig.# | Description                                      |
|----------|-------|--|
| 334-860  | 1     | Restrictor Can; 4-7/16"H x 12-5/8" Dia.          |
| 334-861  | 1     | Restrictor Can; 5-11/64"H x 11-5/8"Dia.          |
| 325-156  | 2     | Spring, Rubber; 8"H x 9-1/2"Dia.                 |
| 334-865  | 3     | Plate, Bottom Spring; 11-1/2" x 10 Deg.          |
| 334-867  | 3     | Bottom Spring Plate; 11-1/2" x 13 Deg.           |
| 338-1905 | 4     | Walking Beam, 52"L x 11-1/4"H                    |
| 338-1958 | 4     | Walking Beam, 52"L x 10"H                        |
| 334-945  | 5     | Plate, Beam End Repair - All Beams               |
| 338-1406 | 6     | Saddle; Rockwell Axles                           |
| 338-1407 | 6     | Saddle, High                                     |
| 338-1404 | 6     | Saddle; 5" Round                                 |
| 345-677  | 7     | Torque Rod, Rigid; 15-7/8"                       |
| SP       | 7     | Torque Rod, Rigid, Offset, 46K Susp.             |
| SP       | 7     | Torque Rod, Rigid, 15-7/8", 46K Susp.            |
| 345-674  | 7     | Torque Rod, Rigid; 21-1/2"                       |
| 345-676  | 7     | Torque Rod, Rigid; 23"                           |
| 345-685  | 8     | Torque Rod, Adjustable; 23" Mean Length          |
| 345-678  | 8     | Torque Rod, Adjustable; 21-1/2" Mean Length      |
| 321-273  | 9     | Bushing; 2-3/8"ID x 3-1/8"OD                     |
| 321-273U | 9     | Bushing, Urethane                                |
| 321-274  | 9     | Bushing; 2-3/8"ID x 3-7/32"OD                    |
| 321-276  | 9     | Bushing; 2-9/16"ID x 4-1/4"OD                    |
| 321-277  | 9     | Bushing; 2-9/16"ID x 4-1/2"OD                    |
| 321-275  | 10    | Cap, Type "0" Joint; 40K Susp. Prior to 06/01/92 |
| 334-853  | 10    | Cap, Type "1" Joint; 40K Susp. After 06/01/92    |
| 334-855  | 10    | Cap, Type "2" Joint; 46K Suspension              |
| 334-624  | 11    | Bolt Assembly; 5/8"-11 x 3-1/2"                  |
| 334-754  | 11    | Bolt Assembly; 5/8"-18 x 5-1/2"Lg.               |
| 334-770  | 11    | Bolt Assembly; 5/8"-18 x 5"Lg.                   |
| M74003   | 12    | Shock Absorber                                   |
| M74400   | 12    | Shock Absorber                                   |
| 401754   | ---   | Shock Bushing, 1"ID                              |

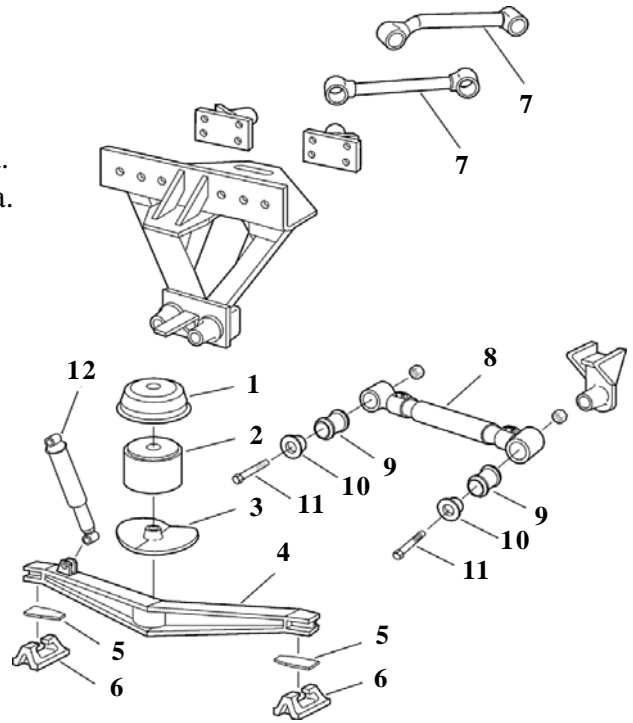

SP Denotes Special Order

# TRAILER SPRINGS

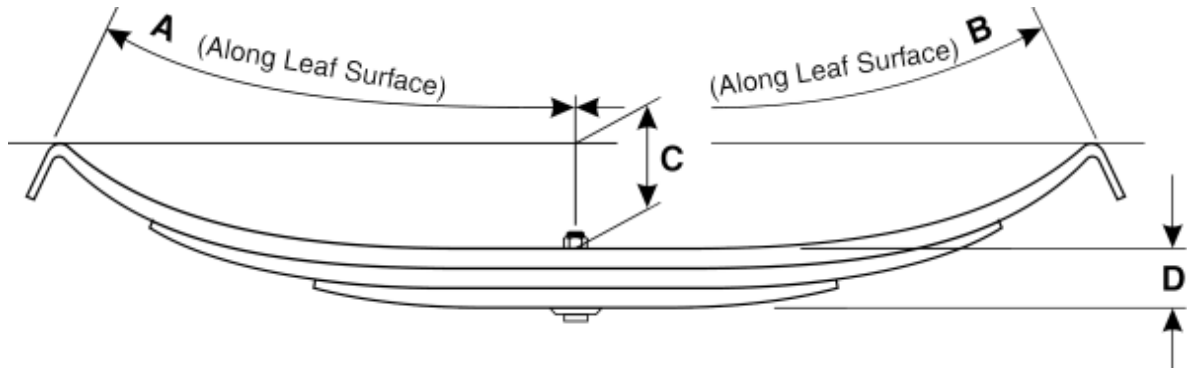

## Hutch H7700 / H9700 Suspension

| Part #   | OEM #  | Leaves | Arch | A       | B        | C        | D        | Capacity Per Spring |
|----------|--------|--------|------|---------|----------|----------|----------|---------------------|
| TRA-021  | 363-00 | 1      | Low  | 21-7/8" | 23-1/4"  | 4-11/16" | 1-3/8"   | 11,200              |
| TRA-023  | 360-00 | 1      | High | 22-1/2" | 24-3/16" | 7-1/16"  | 1-3/8"   | 11,200              |
| TRA-2717 | 751-42 | 6      | Low  | 18-7/8" | 18-7/8"  | 3-7/8"   | 3"       | 11,200              |
| TRA-2726 | 354-00 | 3      | High | 22-1/2" | 23-5/8"  | 6"       | 2-1/2"   | 11,200              |
| TRA-2727 | 355-00 | 3      | Med  | 21-3/4" | 22-7/8"  | 4-1/2"   | 2-1/2"   | 11,200              |
| TRA-2728 | 356-00 | 3      | Low  | 21-1/4" | 22-7/16" | 3-5/8"   | 2-1/2"   | 11,200              |
| TRA-2741 | 365-01 | 3      | Low  | 21-1/2" | 22-3/4"  | 3-1/4"   | 2-15/16" | 12,000              |
| TRA-2740 | 365-00 | 3      | High | 22"     | 22-3/4"  | 5-1/2"   | 2-15/16" | 12,000              |
| TRA-2752 | 324-01 | 2      | High | 22-1/2" | 24"      | 6-3/4"   | 1-15/16" | 11,200              |
| TRA-2754 | 326-01 | 2      | Low  | 21-5/8" | 23-1/4"  | 4-1/4"   | 1-15/16" | 11,200              |

## Reyco / Transpro 86 / 88 Suspension

| Part #   | OEM #   | Leaves | Arch | A       | B       | C      | D      | Capacity Per Spring |
|----------|---------|--------|------|---------|---------|--------|--------|---------------------|
| TRA-3331 | 0335-00 | 3      | Low  | 21-1/2" | 21-1/2" | 2-3/4" | 2-1/2" | 11,000              |
| TRA-3340 | 0079-01 | 3      | High | 22-1/2" | 24-1/8" | 5-7/8" | 2-1/2" | 11,000              |
| TRA-3341 | 0079-02 | 3      | Low  | 21"     | 23-3/4" | 3"     | 2-1/2" | 11,000              |



Fig. 1

## Spring Accessories

| Part #  | Fig.# | Description                       |
|---------|-------|-----------------------------------|
| CB-3810 | 1     | 3/8" Dia. 10" Spring Center Bolt  |
| CB-1510 | 1     | 1/2" Dia. 10" Spring Center Bolt  |
| CB-7610 | 1     | 7/16" Dia. 10" Spring Center Bolt |



# U-BOLTS

## 3" Round

| Part #  | Fig.# | Thread  | A       | B  | C  |
|---------|-------|---------|---------|----|----|
| 361-482 | 1     | 3/4"-16 | 9-5/8"  | 3" | 3" |
| 361-469 | 1     | 3/4"-16 | 12-5/8" | 3" | 3" |
| 361-64  | 1     | 3/4"-16 | 13-5/8" | 3" | 6" |
| 361-196 | 1     | 3/4"-16 | 15-5/8" | 3" | 6" |
| 361-262 | 1     | 3/4"-16 | 18-5/8" | 3" | 6" |
| 361-248 | 1     | 7/8"-14 | 12-1/2" | 3" | 4" |
| 361-218 | 1     | 7/8"-14 | 14-1/2" | 3" | 4" |
| 361-492 | 1     | 7/8"-14 | 16-1/2" | 3" | 6" |
| 361-250 | 1     | 7/8"-14 | 18-1/2" | 3" | 6" |

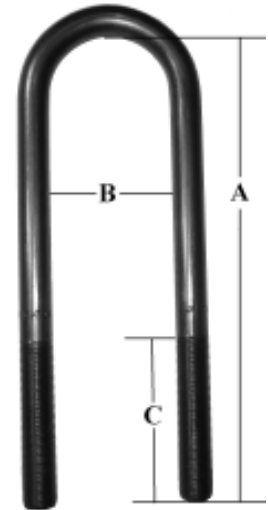

Fig. 1

## 5" Round

| Part #  | Fig.# | Thread  | A       | B  | C  |
|---------|-------|---------|---------|----|----|
| 7816-10 | 1     | 7/8"-14 | 11-3/4" | 5" | 3" |
| 361-258 | 1     | 7/8"-14 | 11-7/8" | 5" | 6" |
| 361-252 | 1     | 7/8"-14 | 13-7/8" | 5" | 6" |

## Nuts & Washers

| Part # | Fig.# | Description           |
|--------|-------|-----------------------|
| DN34   | 2     | 3/4"-16 U-Bolt Hi-Nut |
| DN78   | 2     | 7/8"-14 U-Bolt Hi-Nut |
| SUW34  | 3     | 3/4" I.D. Washer      |
| SUW78  | 3     | 7/8" I.D. Washer      |



Fig. 2



Fig. 3

**Don't See The U-Bolt You Need?  
We Custom Bend U-Bolts.  
See Page 5.**

# SHOCK ABSORBERS



## Truck

| <u>Part #</u> | <u>Description</u> |
|---------------|--------------------|
|---------------|--------------------|

### Freightliner

Models: Argosy, Columbia, FL, and 112 w/ FAS II Suspension

M65490 Rear Shock

Models: 112 Conventional, 120, and Cab-Over

M65103 Front Shock

### Kenworth w/ Air Glide 100 Air Suspension

M65404 Rear Shock

### Kenworth w/ Front Taperleaf Spring

M65102 Front Shock

### Peterbilt w/ Front Spring Suspension

M65101 Front Shock

### Volvo w/ Single Front Shock Absorber

M65105 Front Shock

## Trailer

### Great Dane w/ Reyco Suspension

| <u>Part #</u> | <u>Description</u> |
|---------------|--------------------|
|---------------|--------------------|

M66886 Reyco Series 87

M66893 Reyco Series 88

### Hendrickson

Models: HC230, HF230, HT230, HT250U, INTRAAX

| <u>Part #</u> | <u>Description</u> |
|---------------|--------------------|
|---------------|--------------------|

M65416 Rear Shock



# SHOCK INTERCHANGE

## Interchange

| <u>Freightliner</u> | = | <u>Dayton</u> | <u>Gabriel</u> | = | <u>Dayton</u> |
|---------------------|---|---------------|----------------|---|---------------|
| 680339              |   | M65490        | 83113          |   | 66636         |
| 680339              |   | M74425        | 83124          |   | 66886         |
| 680425              |   | M65490        | 83203          |   | 66893         |
| 90044162            |   | M66893        | 83204          |   | 66636         |
| 10-12030-000        |   | M65103        | 83207          |   | 66886         |
| 10-12032-000        |   | M65103        | 85008          |   | 66636         |
| 10-12032-001        |   | M65103        | 85012          |   | 65101         |
| 10-12032-002        |   | M65103        | 85014          |   | 66886         |
| 10-12032-003        |   | M65103        | 85029          |   | 66636         |
| 10-12032-004        |   | M65103        | 85046          |   | 65415         |
| 10-12046-000        |   | M65103        | 85052          |   | 66607         |
| 16-13957-000        |   | M65490        | 85060          |   | 66636         |
| 16-13957-003        |   | M74425        | 85061          |   | 65130         |
| 16-13957-003        |   | M74425        | 85320          |   | 65103         |
| 16-15817-000        |   | M65490        | 85323          |   | 65416         |
| 16-15817-000        |   | M74425        | 85710          |   | 65444         |
| 16-16591-000        |   | M65490        | 89410          |   | 65102         |
| 16-16591-000        |   | M74425        | 89417          |   | 65105         |
| 16-3957-003         |   | M65490        | 89423          |   | 65404         |
|                     |   |               | 89429          |   | 65103         |
|                     |   |               | 89434          |   | 65415         |

| <u>Napa</u> | = | <u>Dayton</u> | <u>Neway</u> | = | <u>Dayton</u> | <u>Kenworth</u> | = | <u>Dayton</u> |
|-------------|---|---------------|--------------|---|---------------|-----------------|---|---------------|
| 650101      |   | 65101         | 90044089     |   | 66886         | 90044089        |   | 66886         |
| 650102      |   | 65102         | K374-11      |   | 65102         | 90044684        |   | 66886         |
| 650103      |   | 65103         | K374-16      |   | 65102         | 90044833        |   | 66607         |
| 650105      |   | 65105         | K374-26      |   | 65102         | 90044834        |   | 66607         |
| 650130      |   | 65130         | K374-27      |   | 65102         | 90044089C       |   | 66886         |
| 650404      |   | 65404         | K374-29      |   | 65404         | AR-958          |   | 66886         |
| 650415      |   | 65415         | K374-32      |   | 65404         |                 |   |               |
| 650416      |   | 65416         | K374-7       |   | 65404         |                 |   |               |
| 650444      |   | 65444         | K374-87      |   | 65404         |                 |   |               |
| 660103      |   | 66886         | K374-9       |   | 65404         |                 |   |               |
| 660104      |   | 66893         | K374-C7      |   | 65404         |                 |   |               |
| 660166      |   | 66607         |              |   |               |                 |   |               |
| 660502      |   | 66502         |              |   |               |                 |   |               |



# GOODYEAR AIR SPRINGS

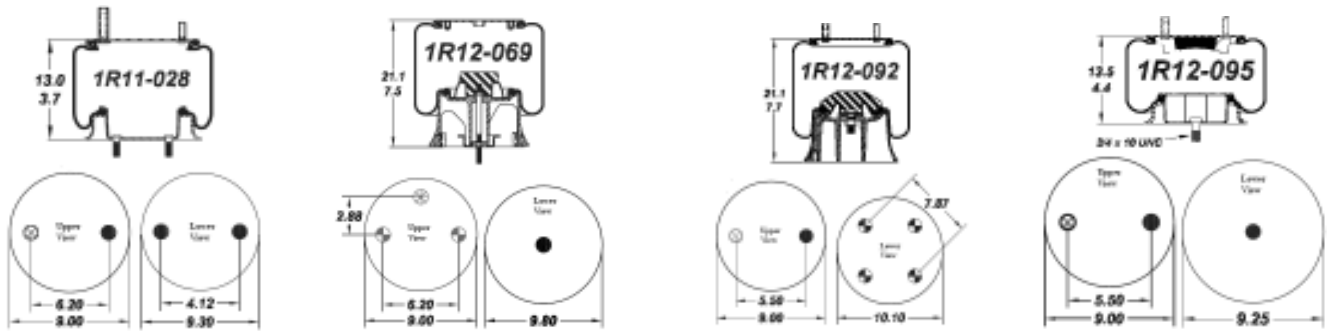

- Bolt or Stud - 1/2-13 or 1/2-20
- ⊗ Air Fiting - 1/4 NPTF
- Stud - 3/4-10
- ⊖ Tapped Hole on Top Retainers 3/8-16, on Pistons - 1/2-13
- ⊗ Air Fiting - 1/2 NPTF or 3/8 NPTF
- ⊗ Combination Stud Air Fiting Stud - 3/4-10; Air Fiting - 1/4 NPTF

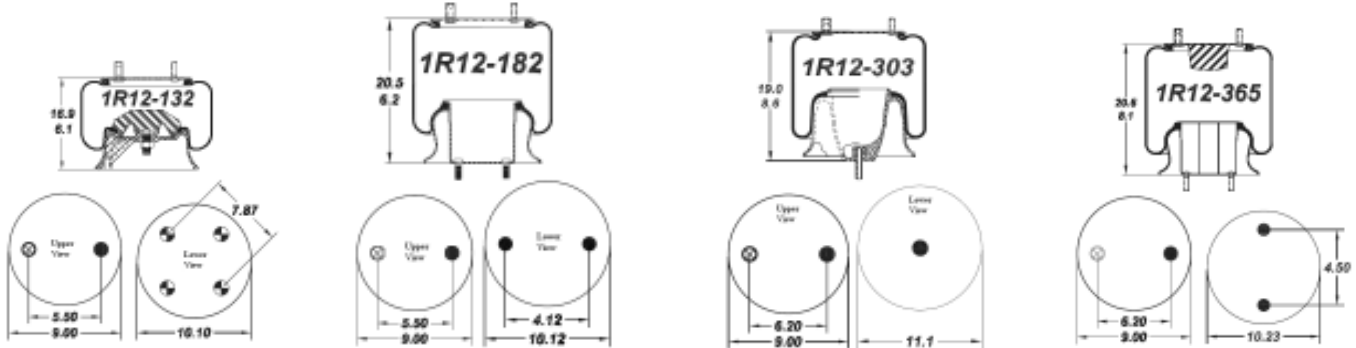

- Bolt or Stud - 1/2-13 or 1/2-20
- ⊗ Air Fiting - 1/4 NPTF
- Stud - 3/4-10
- ⊖ Tapped Hole on Top Retainers 3/8-16, on Pistons - 1/2-13
- ⊗ Air Fiting - 1/2 NPTF or 3/8 NPTF
- ⊗ Combination Stud Air Fiting Stud - 3/4-10; Air Fiting - 1/4 NPTF

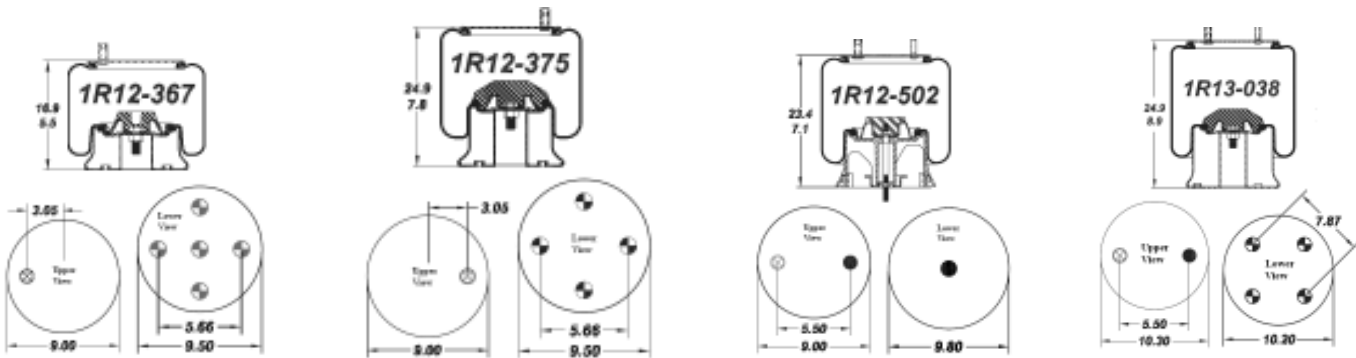

## Interchange

### Firestone = Goodyear

|      |          |
|------|----------|
| 6897 | 2B9-229  |
| 6902 | 2B9-201  |
| 6905 | 2B9-206  |
| 6943 | 2B9-250  |
| 7795 | 2B10-226 |
| 7816 | 3B14-359 |

### Firestone = Goodyear

|      |          |
|------|----------|
| 7818 | 3B14-359 |
| 7839 | 3B14-359 |
| 8008 | 3B12-300 |
| 8033 | 3B12-312 |
| 8050 | 1R14-039 |
| 9069 | 1R12-069 |

### Firestone = Goodyear

|      |          |
|------|----------|
| 9082 | 1R12-092 |
| 9101 | 1R12-103 |
| 9105 | 1R12-132 |
| 9113 | 1R12-132 |
| 9265 | 1R12-375 |
| 9270 | 1R13-119 |

### Firestone = Goodyear

|      |          |
|------|----------|
| 9295 | 1R11-166 |
| 9302 | 1R12-132 |
| 9303 | 1R12-132 |
| 9422 | 1R11-028 |
| 9466 | 1R12-365 |
| 9640 | 1R12-367 |
| 9780 | 1R12-303 |



# GOODYEAR AIR SPRINGS

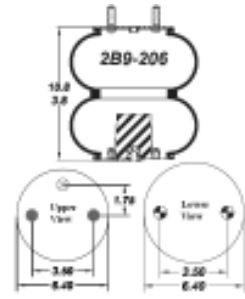
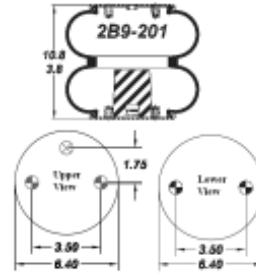
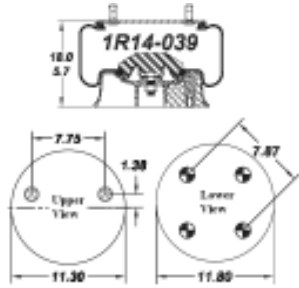
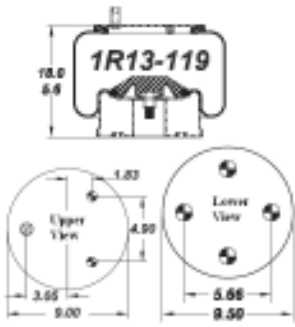

- - Bolt or Stud - 1/2-13 or 1/2-20
- ⊗ - Air Fitting - 1/4 NPTF
- - Stud - 3/4-10
- - Tapped Hole on Top Retainers 3/8-16, on Pistons - 1/2-13
- ⊗ - Air Fitting - 1/2 NPTF or 3/8 NPTF
- ⊗ - Combination Stud Air Fitting Stud - 3/4-16; Air Fitting - 1/4 NPTF

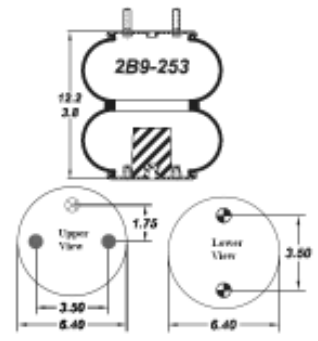
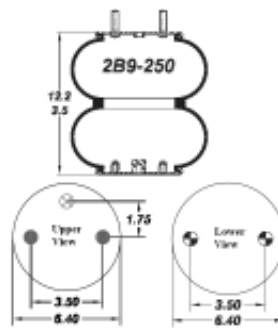
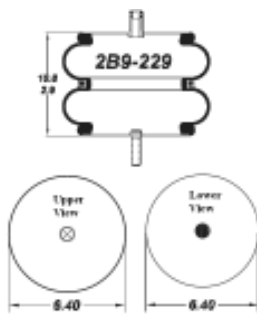
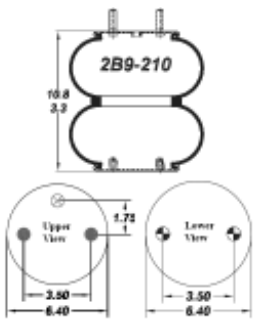

- - Bolt or Stud - 1/2-13 or 1/2-20
- ⊗ - Air Fitting - 1/4 NPTF
- - Stud - 3/4-10
- - Tapped Hole on Top Retainers 3/8-16, on Pistons - 1/2-13
- ⊗ - Air Fitting - 1/2 NPTF or 3/8 NPTF
- ⊗ - Combination Stud Air Fitting Stud - 3/4-16; Air Fitting - 1/4 NPTF

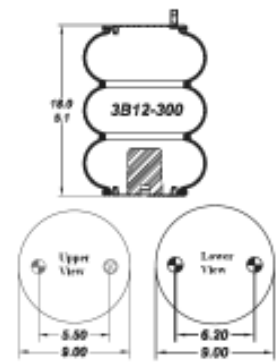
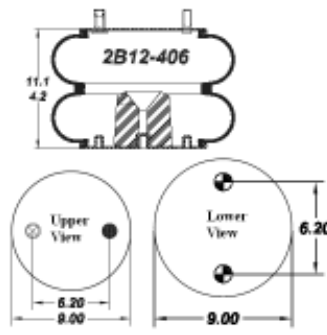
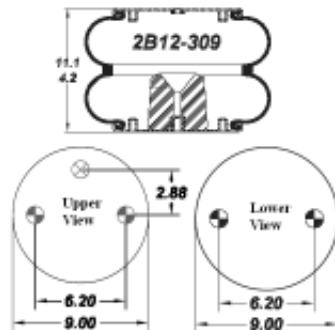
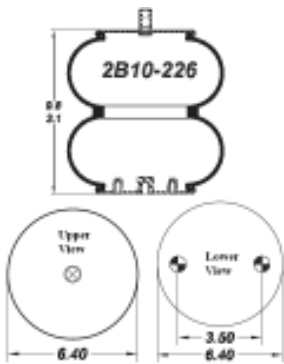

## Interchange

| <u>Neway</u> | = | <u>Goodyear</u> |
|--------------|---|-----------------|
| 900-44-701   |   | 1R12-103        |
| 905-057-009  |   | 1R12-103        |
| 905-57-008   |   | 1R12-103        |
| 905-57-011   |   | 1R12-095        |
| 905-57-016   |   | 2B12-309        |
| 905-57-023   |   | 1R12-095        |
| 905-57-071   |   | 1R13-038        |

| <u>Neway</u> | = | <u>Goodyear</u> |
|--------------|---|-----------------|
| 905-57-075   |   | 1R12-092        |
| 905-57-076   |   | 1R13-038        |
| 905-57-077   |   | 1R13-038        |
| 905-57-082   |   | 1R12-103        |
| 905-57-085   |   | 1R12-095        |
| AR-1517-1-F  |   | 1R12-095        |
| TC-144-4     |   | 2B12-309        |

| <u>Triangle</u> | = | <u>Goodyear</u> |
|-----------------|---|-----------------|
| 4310            |   | 2B9-201         |
| 4313            |   | 2B12-309        |
| 4315            |   | 2B9-206         |
| 4362            |   | 2B9-210         |
| 4426            |   | 2B9-250         |
| 4427            |   | 2B9-253         |
| 4431            |   | 3B12-300        |
| 4469            |   | 3B12-300        |
| 4499            |   | 2B9-201         |

| <u>Triangle</u> | = | <u>Goodyear</u> |
|-----------------|---|-----------------|
| 4505            |   | 2B9-229         |
| 8312            |   | 1R12-069        |
| 8319            |   | 1R12-132        |
| 8382            |   | 1R12-303        |
| 8408            |   | 1R12-182        |
| 8410            |   | 1R12-365        |
| 8427            |   | 1R12-367        |
| 8433            |   | 1R13-119        |
| 8435            |   | 1R12-375        |
| 8443            |   | 1R12-502        |

